

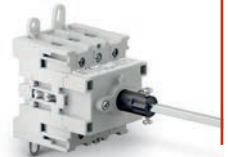



Rear-mount switches



Base mount switches



## IP66 handles with screw fixing

Padlockable handles		poles	Ie AC21	Two-screw fixing	Pack	Four-screw fixing 36x36 o 48x48*	Pack	Two-screw fixing	Pack
 <p>Grey plate 67x67mm padlockable, black knob</p>	3	50A	DS0503RQK6	1	DS0503PQK6S	1	DS0503BAK6	1	
		63A	DS0633RQK6	1	DS0633PQK6S	1	DS0633BAK6	1	
		80A	DS0803RQK6	1	DS0803PQK6S	1	DS0803BAK6	1	
		100A	DS1003RQK6	1	DS1003PQK6S	1	DS1003BAK6	1	
	3+N	50A	DS0504RQK6	1	DS0504PQK6S	1	DS0504BAK6	1	
		63A	DS0634RQK6	1	DS0634PQK6S	1	DS0634BAK6	1	
		80A	DS0804RQK6	1	DS0804PQK6S	1	DS0804BAK6	1	
		100A	DS1004RQK6	1	DS1004PQK6S	1	DS1004BAK6	1	
 <p>Yellow plate 67x67mm padlockable, red knob</p>	3	50A	DS0503RQL6	1	DS0503PQL6S	1	DS0503BAL6	1	
		63A	DS0633RQL6	1	DS0633PQL6S	1	DS0633BAL6	1	
		80A	DS0803RQL6	1	DS0803PQL6S	1	DS0803BAL6	1	
		100A	DS1003RQL6	1	DS1003PQL6S	1	DS1003BAL6	1	
	3+N	50A	DS0504RQL6	1	DS0504PQL6S	1	DS0504BAL6	1	
		63A	DS0634RQL6	1	DS0634PQL6S	1	DS0634BAL6	1	
		80A	DS0804RQL6	1	DS0804PQL6S	1	DS0804BAL6	1	
		100A	DS1004RQL6	1	DS1004PQL6S	1	DS1004BAL6	1	
 <p>Grey plate 67x67 mm, black knob padlockable</p>	3	50A	DS0503RQT6L	1	-	-	DS0503BAT6L	1	
		63A	DS0633RQT6L	1	-	-	DS0633BAT6L	1	
		80A	DS0803RQT6L	1	-	-	DS0803BAT6L	1	
		100A	DS1003RQT6L	1	-	-	DS1003BAT6L	1	
	3+N	50A	DS0504RQT6L	1	-	-	DS0504BAT6L	1	
		63A	DS0634RQT6L	1	-	-	DS0634BAT6L	1	
		80A	DS0804RQT6L	1	-	-	DS0804BAT6L	1	
		100A	DS1004RQT6L	1	-	-	DS1004BAT6L	1	
 <p>Yellow plate 67x67 mm, red knob padlockable</p>	3	50A	DS0503RQY6L	1	-	-	DS0503BAY6L	1	
		63A	DS0633RQY6L	1	-	-	DS0633BAY6L	1	
		80A	DS0803RQY6L	1	-	-	DS0803BAY6L	1	
		100A	DS1003RQY6L	1	-	-	DS1003BAY6L	1	
	3+N	50A	DS0504RQY6L	1	-	-	DS0504BAY6L	1	
		63A	DS0634RQY6L	1	-	-	DS0634BAY6L	1	
		80A	DS0804RQY6L	1	-	-	DS0804BAY6L	1	
		100A	DS1004RQY6L	1	-	-	DS1004BAY6L	1	

Two-screw fixing, distance between holes: 28mm (1.10") Vertical or 32mm (1.26") Horizontal

Four-screw fixing, distance between holes: 48x48mm (1.89"x1.89")

\* Fixing 48x48 (1.89"x1.89") with adapter flange (included in the package)





Rear-mount switches

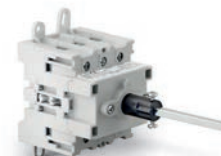

Base mount switches



■ IP66 handles with screw fixing

Padlockable handles		poles	Ie AC21	Two-screw fixing	Pack	Four-screw fixing 36x36 or 48x48	Pack	Two-screw fixing	Pack
 <p>Grey plate 48x48 mm, black knob padlockable</p>	3	50A	DS0503RQT4L	1	-	-	DS0503BAT4L	1	
		63A	DS0633RQT4L	1	-	-	DS0633BAT4L	1	
		80A	DS0803RQT4L	1	-	-	DS0803BAT4L	1	
		100A	DS1003RQT4L	1	-	-	DS1003BAT4L	1	
	3+N	50A	DS0504RQT4L	1	-	-	DS0504BAT4L	1	
		63A	DS0634RQT4L	1	-	-	DS0634BAT4L	1	
		80A	DS0804RQT4L	1	-	-	DS0804BAT4L	1	
		100A	DS1004RQT4L	1	-	-	DS1004BAT4L	1	
 <p>Yellow plate 48x48 mm, red knob padlockable</p>	3	50A	DS0503RQY4L	1	-	-	DS0503BAY4L	1	
		63A	DS0633RQY4L	1	-	-	DS0633BAY4L	1	
		80A	DS0803RQY4L	1	-	-	DS0803BAY4L	1	
		100A	DS1003RQY4L	1	-	-	DS1003BAY4L	1	
	3+N	50A	DS0504RQY4L	1	-	-	DS0504BAY4L	1	
		63A	DS0634RQY4L	1	-	-	DS0634BAY4L	1	
		80A	DS0804RQY4L	1	-	-	DS0804BAY4L	1	
		100A	DS1004RQY4L	1	-	-	DS1004BAY4L	1	
Padlockable handles		poles	Ie AC21	Two-screw fixing	Pack	Four-screw fixing 36x36 or 48x48	Pack	Four-screw fixing 36x36 or 48x48*	Pack
 <p>Grey plate 67x67 mm black knob padlockable</p>	3	50A	-	-	-	-	DS0503BAK6S	1	
		63A	-	-	-	-	DS0633BAK6S	1	
		80A	-	-	-	-	DS0803BAK6S	1	
		100A	-	-	-	-	DS1003BAK6S	1	
	3+N	50A	-	-	-	-	DS0504BAK6S	1	
		63A	-	-	-	-	DS0634BAK6S	1	
		80A	-	-	-	-	DS0804BAK6S	1	
		100A	-	-	-	-	DS1004BAK6S	1	
 <p>Yellow plate 67x67 mm red knob padlockable</p>	3	50A	-	-	-	-	DS0503BAL6S	1	
		63A	-	-	-	-	DS0633BAL6S	1	
		80A	-	-	-	-	DS0803BAL6S	1	
		100A	-	-	-	-	DS1003BAL6S	1	
	3+N	50A	-	-	-	-	DS0504BAL6S	1	
		63A	-	-	-	-	DS0634BAL6S	1	
		80A	-	-	-	-	DS0804BAL6S	1	
		100A	-	-	-	-	DS1004BAL6S	1	

Two-screw fixing, distance between holes: 28mm (1.10") Vertical or 32mm (1.26") Horizontal

\* Fixing 48x48 (1,89"x1,89") with adapter flange (included in the package)

 standard article





## Rear-mount switches

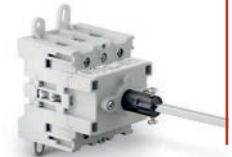

## Base mount switches



### ■ IP66 handles with screw fixing

Non padlockable handles		poles	Ie AC21	Two-screw fixing	Pack	Four-screw fixing 36x36 o 48x48*	Pack	Two-screw fixing	Pack
 <p>Grey plate 64x64 mm, black knob</p>	3	50A	-	-	DS0503PQV6	1	DS0503BAV6	1	
		63A	-	-	DS0633PQV6	1	DS0633BAV6	1	
		80A	-	-	DS0803PQV6	1	DS0803BAV6	1	
		100A	-	-	DS1003PQV6	1	DS1003BAV6	1	
	3+N	50A	-	-	DS0504PQV6	1	DS0504BAV6	1	
		63A	-	-	DS0634PQV6	1	DS0634BAV6	1	
		80A	-	-	DS0804PQV6	1	DS0804BAV6	1	
		100A	-	-	DS1004PQV6	1	DS1004BAV6	1	
 <p>Grey plate 48x48 mm, black knob</p> <p>Four-screw fixing at 36x36mm only</p>	3	50A	-	-	DS0503PQV4	1	DS0503BAV4	1	
		63A	-	-	DS0633PQV4	1	DS0633BAV4	1	
		80A	-	-	DS0803PQV4	1	DS0803BAV4	1	
		100A	-	-	DS1003PQV4	1	DS1003BAV4	1	
	3+N	50A	-	-	DS0504PQV4	1	DS0504BAV4	1	
		63A	-	-	DS0634PQV4	1	DS0634BAV4	1	
		80A	-	-	DS0804PQV4	1	DS0804BAV4	1	
		100A	-	-	DS1004PQV4	1	DS1004BAV4	1	
 <p>Yellow plate 64x64 mm, red knob</p>	3	50A	-	-	DS0503PQW6	1	DS0503BAW6	1	
		63A	-	-	DS0633PQW6	1	DS0633BAW6	1	
		80A	-	-	DS0803PQW6	1	DS0803BAW6	1	
		100A	-	-	DS1003PQW6	1	DS1003BAW6	1	
	3+N	50A	-	-	DS0504PQW6	1	DS0504BAW6	1	
		63A	-	-	DS0634PQW6	1	DS0634BAW6	1	
		80A	-	-	DS0804PQW6	1	DS0804BAW6	1	
		100A	-	-	DS1004PQW6	1	DS1004BAW6	1	
 <p>Yellow plate 48x48 mm, red knob</p> <p>Four-screw fixing at 36x36mm only</p>	3	50A	-	-	DS0503PQW4	1	DS0503BAW4	1	
		63A	-	-	DS0633PQW4	1	DS0633BAW4	1	
		80A	-	-	DS0803PQW4	1	DS0803BAW4	1	
		100A	-	-	DS1003PQW4	1	DS1003BAW4	1	
	3+N	50A	-	-	DS0504PQW4	1	DS0504BAW4	1	
		63A	-	-	DS0634PQW4	1	DS0634BAW4	1	
		80A	-	-	DS0804PQW4	1	DS0804BAW4	1	
		100A	-	-	DS1004PQW4	1	DS1004BAW4	1	

Two-screw fixing, distance between holes: 28mm (1.10") Vertical or 32mm (1.26") Horizontal  
 Four-screw fixing, distance between holes: 36x36mm (1.42"x1.42") or 48x48mm (1.89"x1.89")





Rear-mount switches

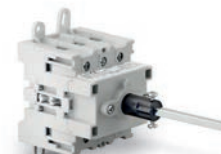

Base mount switches



■ IP66 handles with screw fixing

Non padlockable handles		poles	Ie AC21	Two-screw fixing	Pack	Four-screw fixing 36x36 o 48x48	Pack	Two-screw fixing	Pack
 <p>Grey plate 67x67 mm, black knob</p>	3	50A	DS0503RQT6	1	-	-	DS0503BAT6	1	
		63A	DS0633RQT6	1	-	-	DS0633BAT6	1	
		80A	DS0803RQT6	1	-	-	DS0803BAT6	1	
		100A	DS1003RQT6	1	-	-	DS1003BAT6	1	
	3+N	50A	DS0504RQT6	1	-	-	DS0504BAT6	1	
		63A	DS0634RQT6	1	-	-	DS0634BAT6	1	
		80A	DS0804RQT6	1	-	-	DS0804BAT6	1	
		100A	DS1004RQT6	1	-	-	DS1004BAT6	1	
 <p>Yellow plate 67x67 mm, red knob</p>	3	50A	DS0503RQY6	1	-	-	DS0503BAY6	1	
		63A	DS0633RQY6	1	-	-	DS0633BAY6	1	
		80A	DS0803RQY6	1	-	-	DS0803BAY6	1	
		100A	DS1003RQY6	1	-	-	DS1003BAY6	1	
	3+N	50A	DS0504RQY6	1	-	-	DS0504BAY6	1	
		63A	DS0634RQY6	1	-	-	DS0634BAY6	1	
		80A	DS0804RQY6	1	-	-	DS0804BAY6	1	
		100A	DS1004RQY6	1	-	-	DS1004BAY6	1	
 <p>Grey plate 48x48 mm, black knob</p>	3	50A	DS0503RQT4	1	-	-	DS0503BAT4	1	
		63A	DS0633RQT4	1	-	-	DS0633BAT4	1	
		80A	DS0803RQT4	1	-	-	DS0803BAT4	1	
		100A	DS1003RQT4	1	-	-	DS1003BAT4	1	
	3+N	50A	DS0504RQT4	1	-	-	DS0504BAT4	1	
		63A	DS0634RQT4	1	-	-	DS0634BAT4	1	
		80A	DS0804RQT4	1	-	-	DS0804BAT4	1	
		100A	DS1004RQT4	1	-	-	DS1004BAT4	1	
 <p>Yellow plate 48x48 mm, red knob</p>	3	50A	DS0503RQY4	1	-	-	DS0503BAY4	1	
		63A	DS0633RQY4	1	-	-	DS0633BAY4	1	
		80A	DS0803RQY4	1	-	-	DS0803BAY4	1	
		100A	DS1003RQY4	1	-	-	DS1003BAY4	1	
	3+N	50A	DS0504RQY4	1	-	-	DS0504BAY4	1	
		63A	DS0634RQY4	1	-	-	DS0634BAY4	1	
		80A	DS0804RQY4	1	-	-	DS0804BAY4	1	
		100A	DS1004RQY4	1	-	-	DS1004BAY4	1	

Two-screw fixing, distance between holes: 28mm (1.10") Vertical or 32mm (1.26") Horizontal

 standard article





## Rear-mount switches

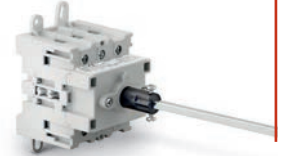

## Base mount switches



### ■ IP66 handles with Ø22mm (0,87") single-hole and nut fixing

Padlockable handles		poles	Ie AC21	Ø22mm (0,87") single-hole and nut fixing	Pack	Ø22mm (0,87") single-hole and nut fixing	Pack
 <p>Grey plate 67x67mm padlockable, black knob</p>	3	50A	DS0503GDK6	1	DS0503BFK6	1	
		63A	DS0633GDK6	1	DS0633BFK6	1	
		80A	DS0803GDK6	1	DS0803BFK6	1	
		100A	DS1003GDK6	1	DS1003BFK6	1	
	3+N	50A	DS0504GDK6	1	DS0504BFK6	1	
		63A	DS0634GDK6	1	DS0634BFK6	1	
		80A	DS0804GDK6	1	DS0804BFK6	1	
		100A	DS1004GDK6	1	DS1004BFK6	1	
 <p>Yellow plate 67x67mm padlockable, red knob</p>	3	50A	DS0503GDL6	1	DS0503BFL6	1	
		63A	DS0633GDL6	1	DS0633BFL6	1	
		80A	DS0803GDL6	1	DS0803BFL6	1	
		100A	DS1003GDL6	1	DS1003BFL6	1	
	3+N	50A	DS0504GDL6	1	DS0504BFL6	1	
		63A	DS0634GDL6	1	DS0634BFL6	1	
		80A	DS0804GDL6	1	DS0804BFL6	1	
		100A	DS1004GDL6	1	DS1004BFL6	1	
 <p>Grey plate 67x67 mm, black knob padlockable</p>	3	50A	DS0503GDT6L	1	DS0503BFT6L	1	
		63A	DS0633GDT6L	1	DS0633BFT6L	1	
		80A	DS0803GDT6L	1	DS0803BFT6L	1	
		100A	DS1003GDT6L	1	DS1003BFT6L	1	
	3+N	50A	DS0504GDT6L	1	DS0504BFT6L	1	
		63A	DS0634GDT6L	1	DS0634BFT6L	1	
		80A	DS0804GDT6L	1	DS0804BFT6L	1	
		100A	DS1004GDT6L	1	DS1004BFT6L	1	
 <p>Yellow plate 67x67 mm, red knob padlockable</p>	3	50A	DS0503GDY6L	1	DS0503BFY6L	1	
		63A	DS0633GDY6L	1	DS0633BFY6L	1	
		80A	DS0803GDY6L	1	DS0803BFY6L	1	
		100A	DS1003GDY6L	1	DS1003BFY6L	1	
	3+N	50A	DS0504GDY6L	1	DS0504BFY6L	1	
		63A	DS0634GDY6L	1	DS0634BFY6L	1	
		80A	DS0804GDY6L	1	DS0804BFY6L	1	
		100A	DS1004GDY6L	1	DS1004BFY6L	1	



Rear-mount switches

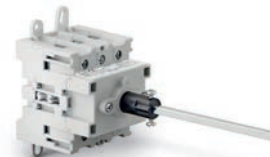

Base mount switches



■ IP66 handles with Ø22mm (0,87") single-hole and nut fixing

Padlockable handles		poles	Ie AC21	Ø22mm (0,87") single-hole and nut fixing	Pack	Ø22mm (0,87") single-hole and nut fixing	Pack
 <p>Grey plate 48x48 mm, black knob padlockable</p>	3	50A	DS0503GDT4L	1	DS0503BFT4L	1	
		63A	DS0633GDT4L	1	DS0633BFT4L	1	
		80A	DS0803GDT4L	1	DS0803BFT4L	1	
		100A	DS1003GDT4L	1	DS1003BFT4L	1	
	3+N	50A	DS0504GDT4L	1	DS0504BFT4L	1	
		63A	DS0634GDT4L	1	DS0634BFT4L	1	
		80A	DS0804GDT4L	1	DS0804BFT4L	1	
		100A	DS1004GDT4L	1	DS1004BFT4L	1	
 <p>Yellow plate 48x48 mm, red knob padlockable</p>	3	50A	DS0503GDY4L	1	DS0503BFY4L	1	
		63A	DS0633GDY4L	1	DS0633BFY4L	1	
		80A	DS0803GDY4L	1	DS0803BFY4L	1	
		100A	DS1003GDY4L	1	DS1003BFY4L	1	
	3+N	50A	DS0504GDY4L	1	DS0504BFY4L	1	
		63A	DS0634GDY4L	1	DS0634BFY4L	1	
		80A	DS0804GDY4L	1	DS0804BFY4L	1	
		100A	DS1004GDY4L	1	DS1004BFY4L	1	







## Rear-mount switches

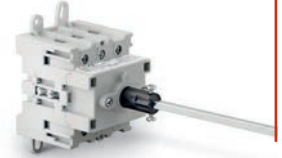

## Base mount switches



### ■ IP66 handles with Ø22mm (0,87") single-hole and nut fixing

Non padlockable handles	poles	Ie AC21	Ø22mm (0,87") single-hole and nut fixing	Pack	Ø22mm (0,87") single-hole and nut fixing	Pack
 <p>Grey plate 67x67 mm, black knob</p>	3	50A	DS0503GDT6	1	DS0503BFT6	1
		63A	DS0633GDT6	1	DS0633BFT6	1
		80A	DS0803GDT6	1	DS0803BFT6	1
		100A	DS1003GDT6	1	DS1003BFT6	1
	3+N	50A	DS0504GDT6	1	DS0504BFT6	1
		63A	DS0634GDT6	1	DS0634BFT6	1
		80A	DS0804GDT6	1	DS0804BFT6	1
		100A	DS1004GDT6	1	DS1004BFT6	1
 <p>Yellow plate 67x67 mm, red knob</p>	3	50A	DS0503GDY6	1	DS0503BFY6	1
		63A	DS0633GDY6	1	DS0633BFY6	1
		80A	DS0803GDY6	1	DS0803BFY6	1
		100A	DS1003GDY6	1	DS1003BFY6	1
	3+N	50A	DS0504GDY6	1	DS0504BFY6	1
		63A	DS0634GDY6	1	DS0634BFY6	1
		80A	DS0804GDY6	1	DS0804BFY6	1
		100A	DS1004GDY6	1	DS1004BFY6	1
 <p>Grey plate 48x48 mm, black knob</p>	3	50A	DS0503GDT4	1	DS0503BFT4	1
		63A	DS0633GDT4	1	DS0633BFT4	1
		80A	DS0803GDT4	1	DS0803BFT4	1
		100A	DS1003GDT4	1	DS1003BFT4	1
	3+N	50A	DS0504GDT4	1	DS0504BFT4	1
		63A	DS0634GDT4	1	DS0634BFT4	1
		80A	DS0804GDT4	1	DS0804BFT4	1
		100A	DS1004GDT4	1	DS1004BFT4	1
 <p>Yellow plate 48x48 mm, red knob</p>	3	50A	DS0503GDY4	1	DS0503BFY4	1
		63A	DS0633GDY4	1	DS0633BFY4	1
		80A	DS0803GDY4	1	DS0803BFY4	1
		100A	DS1003GDY4	1	DS1003BFY4	1
	3+N	50A	DS0504GDY4	1	DS0504BFY4	1
		63A	DS0634GDY4	1	DS0634BFY4	1
		80A	DS0804GDY4	1	DS0804BFY4	1
		100A	DS1004GDY4	1	DS1004BFY4	1





Rear-mount switches

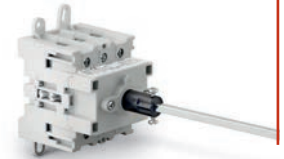

Base mount switches



■ IP66 handles with Ø22mm (0,87") single-hole and nut fixing

Non padlockable handles	poles	Ie AC21	Ø22mm (0,87") single-hole and nut fixing	Pack	Ø22mm (0,87") single-hole and nut fixing	Pack
 <p>Grey plate 64x64 mm, black knob</p>	3	50A	DS0503GDV6	1	DS0503BFV6	1
		63A	DS0633GDV6	1	DS0633BFV6	1
		80A	DS0803GDV6	1	DS0803BFV6	1
		100A	DS1003GDV6	1	DS1003BFV6	1
	3+N	50A	DS0504GDV6	1	DS0504BFV6	1
		63A	DS0634GDV6	1	DS0634BFV6	1
		80A	DS0804GDV6	1	DS0804BFV6	1
		100A	DS1004GDV6	1	DS1004BFV6	1
 <p>Grey plate 48x48 mm, black knob</p>	3	50A	DS0503GDV4	1	DS0503BFV4	1
		63A	DS0633GDV4	1	DS0633BFV4	1
		80A	DS0803GDV4	1	DS0803BFV4	1
		100A	DS1003GDV4	1	DS1003BFV4	1
	3+N	50A	DS0504GDV4	1	DS0504BFV4	1
		63A	DS0634GDV4	1	DS0634BFV4	1
		80A	DS0804GDV4	1	DS0804BFV4	1
		100A	DS1004GDV4	1	DS1004BFV4	1
 <p>Yellow plate 64x64 mm, red knob</p>	3	50A	DS0503GDW6	1	DS0503BFW6	1
		63A	DS0633GDW6	1	DS0633BFW6	1
		80A	DS0803GDW6	1	DS0803BFW6	1
		100A	DS1003GDW6	1	DS1003BFW6	1
	3+N	50A	DS0504GDW6	1	DS0504BFW6	1
		63A	DS0634GDW6	1	DS0634BFW6	1
		80A	DS0804GDW6	1	DS0804BFW6	1
		100A	DS1004GDW6	1	DS1004BFW6	1
 <p>Yellow plate 48x48 mm, red knob</p>	3	50A	DS0503GDW4	1	DS0503BFW4	1
		63A	DS0633GDW4	1	DS0633BFW4	1
		80A	DS0803GDW4	1	DS0803BFW4	1
		100A	DS1003GDW4	1	DS1003BFW4	1
	3+N	50A	DS0504GDW4	1	DS0504BFW4	1
		63A	DS0634GDW4	1	DS0634BFW4	1
		80A	DS0804GDW4	1	DS0804BFW4	1
		100A	DS1004GDW4	1	DS1004BFW4	1



## Base mounting



Direct operation  
Black knob



For standard cabinets  
45mm (1.77") slots  
Black knob

## Rear mounting



2 screw fixing  
at 28mm  
vertical distance



4 screw fixing  
36x36mm (1.42"x1.42")  
or 48x48mm (1.89"x1.89")



ø 22mm (ø 0.87")  
single hole  
and nut fixing

## Direct operation

poles	Ie AC21	Code	Pack	Code	Pack	Code	Pack	Code	Pack	Code	Pack
3	50A	DS0503BFCD	1	DS0503BDDN	1	DS0503R	1	DS0503P	1	DS0503G	1
	63A	DS0633BFCD	1	DS0633BDDN	1	DS0633R	1	DS0633P	1	DS0633G	1
	80A	DS0803BFCD	1	DS0803BDDN	1	DS0803R	1	DS0803P	1	DS0803G	1
	100A	DS1003BFCD	1	DS1003BDDN	1	DS1003R	1	DS1003P	1	DS1003G	1
3+N	50A	DS0504BFCD	1	DS0504BDDN	1	DS0504R	1	DS0504P	1	DS0504G	1
	63A	DS0634BFCD	1	DS0634BDDN	1	DS0634R	1	DS0634P	1	DS0634G	1
	80A	DS0804BFCD	1	DS0804BDDN	1	DS0804R	1	DS0804P	1	DS0804G	1
	100A	DS1004BFCD	1	DS1004BDDN	1	DS1004R	1	DS1004P	1	DS1004G	1

## Additional poles and auxiliary contacts



Code	Description	Pack
XC012AB	Auxiliary contact NO for DS50-63-80-100 base mounting	5
XC012CB	Auxiliary contact NC for DS50-63-80-100 base mounting	5
XC050PB	DS50 4th pole early make/late break (for Neutral) base mounting	5
XC063PB	DS63 4th pole early make/late break (for Neutral) base mounting	5
XC100PB	DS80/DS100 4th pole early make/late break (for Neutral) base mounting	5
XC100GB	Earth pole for DS50-63-80-100 base mounting	5
XC012AR	Auxiliary contact NO for DS50-63-80-100 rear mounting	5
XC012CR	Auxiliary contact NC for DS50-63-80-100 rear mounting	5
XC050PR	DS50 4th pole early make/late break (for Neutral) rear mounting	5
XC063PR	DS63 4th pole early make/late break (for Neutral) rear mounting	5
XC100PR	DS80/DS100 4th pole early make/late break (for Neutral) rear mounting	5
XC100GR	Earth pole for DS50-63-80-100 rear mounting	5

## Shafts



Code	Description	Pack
PALBL300	Shaft L=300mm Q5	5
PALBL500	Shaft L=500mm Q5	5
PALBL055	Shaft L=55mm Q5	5
PALBL075	Shaft L=75mm Q5	5
PALBL095	Shaft L=95mm Q5	5
PALBL115	Shaft L=115mm Q5	5
PALBL135	Shaft L=135mm Q5	5
PALBL155	Shaft L=155mm Q5	5
PALBL175	Shaft L=175mm Q5	5

## Terminal covers



Code	Description	Pack
DS100PR3B	Couple of terminal covers for DS 50-63-80-100A (base mounting)	5
DS100PR1B	Couple of terminal covers for additional pole DS 50-63-80-100A (base mounting)	5
DS100PR3R	Couple of terminal covers for DS 50-63-80-100A (rear mounting)	5
DS100PR1R	Couple of terminal covers for additional pole DS 50-63-80-100A (rear mounting)	5

## ■ Rear mounting - 2 holes with screws

Measures in mm (in)

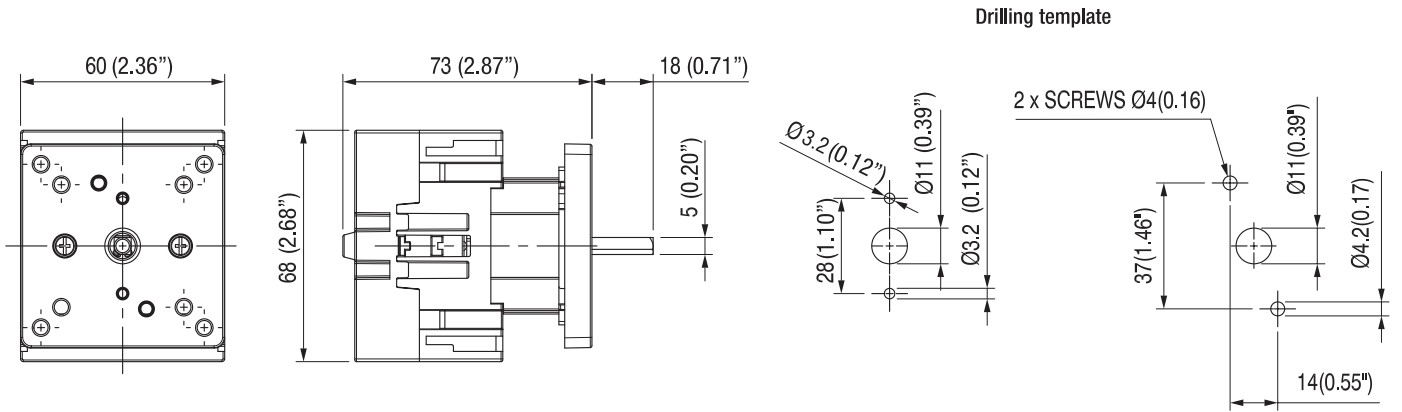

## ■ Rear mounting - 4 holes with screws

Measures in mm (in)

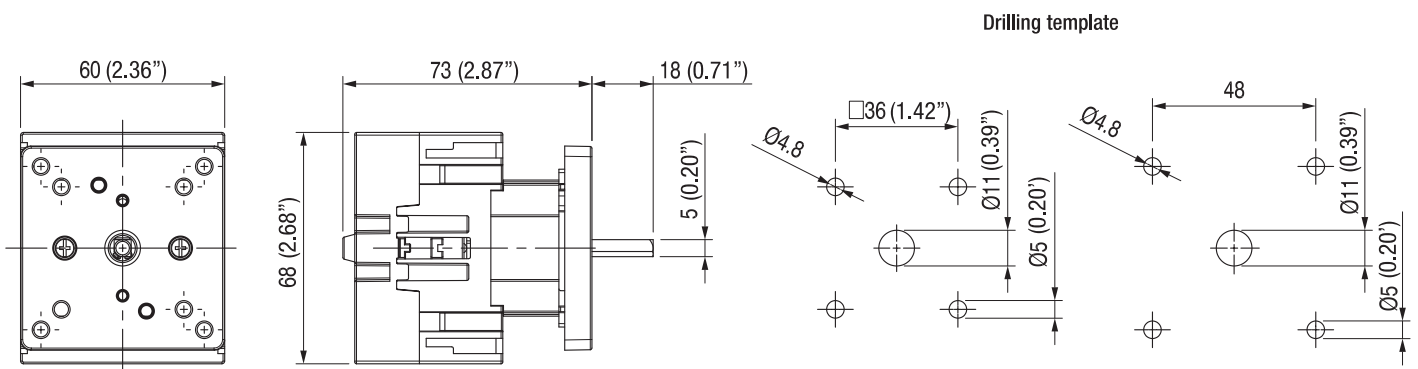

## ■ Rear mounting - $\varnothing 22\text{mm}(0,87)$ single hole with locking nut

Measures in mm (in)

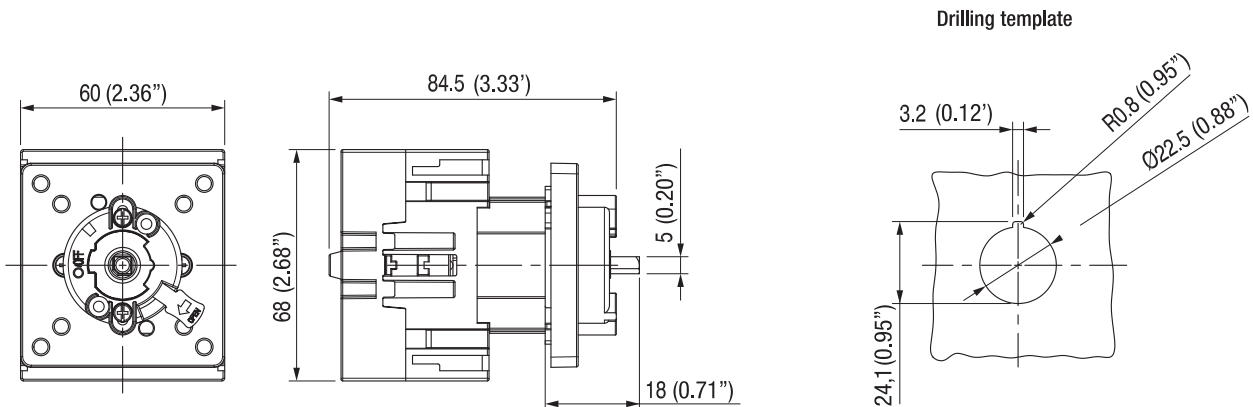

### ■ Base mounting

(DS 50-63-80-100A) - Measures in mm (in)

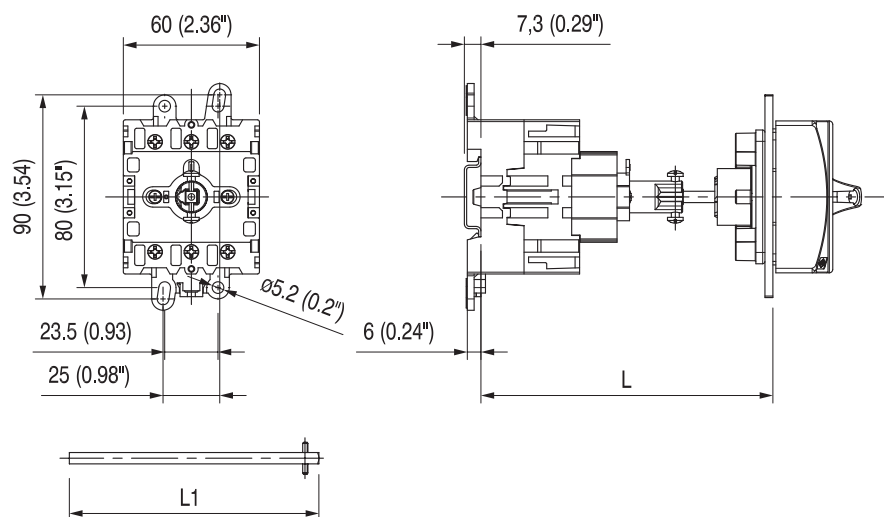

Overall length (min-max)\*\*  
for different shaft length (L1):

L1		
175*	L (mm)	114 - 258
6.89*	L (in)	4.49" - 10.15"
300	L (mm)	114 - 383
11.81	L (in)	4.49" - 15.07"
500	L (mm)	114 - 258
19.68	L (in)	4.49" - 22.95"

\* Standard shaft, bundled  
\*\* Minimum length obtainable by cutting the shaft.

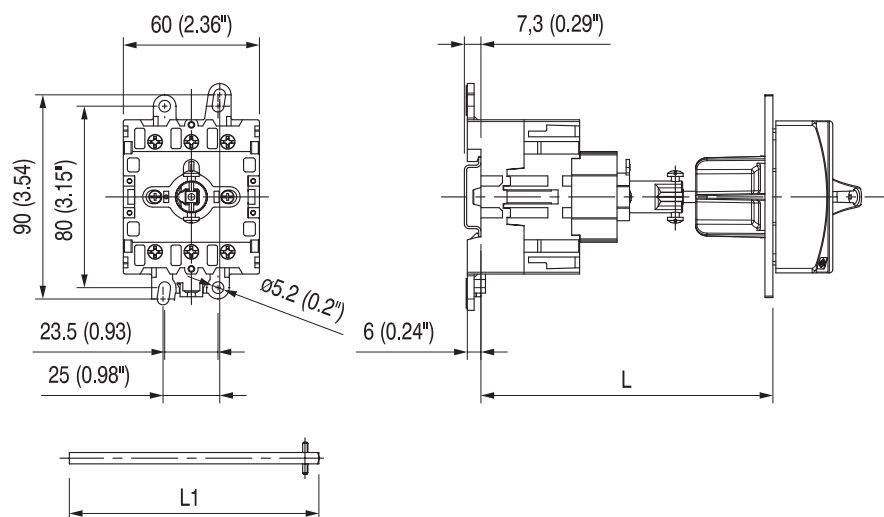

Overall length (min-max)\*\*  
for different shaft length (L1):

L1		
175*	L (mm)	125 - 262
6.89*	L (in)	4.92" - 10.31"
300	L (mm)	125 - 387
11.81	L (in)	4.92" - 15.23"
500	L (mm)	125 - 587
19.68	L (in)	4.92" - 23.11"

\* Standard shaft, bundled  
\*\* Minimum length obtainable by cutting the shaft.

## ■ Base mounting

Measures in mm (in)

### Direct command

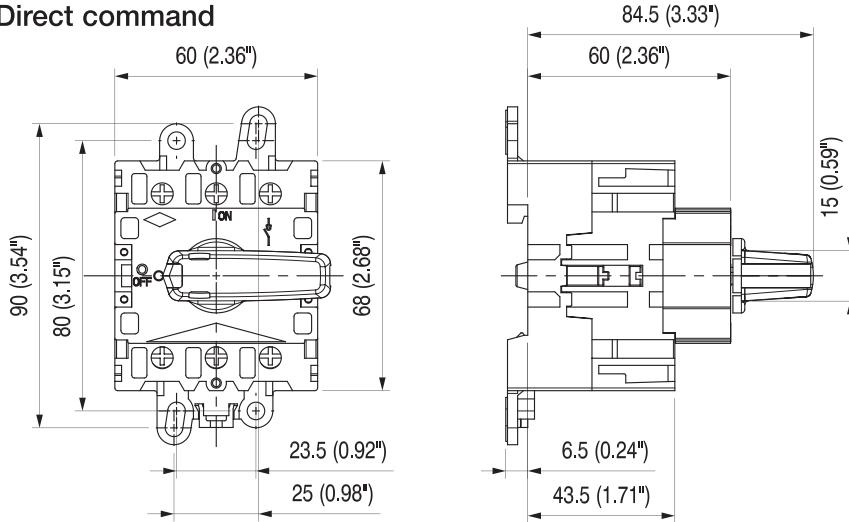

### DDN version - For panel board

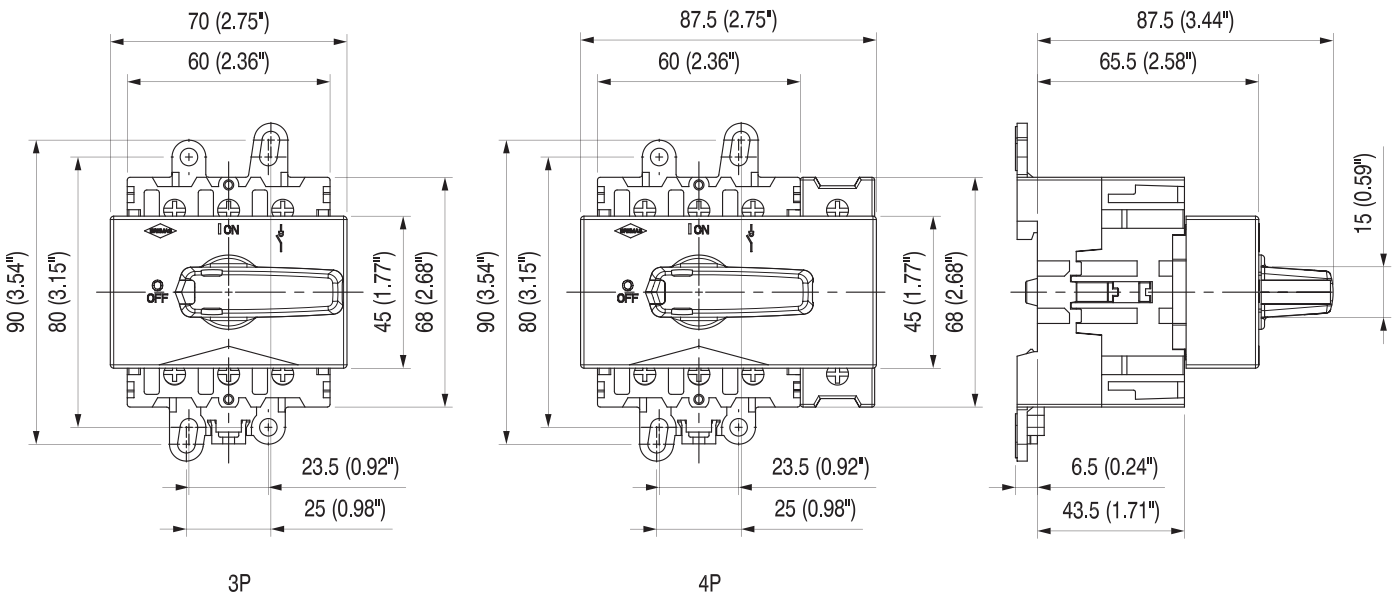

### Fourth pole (additional/auxiliary)

